

Hindbookcenter



Hind Book Center & Photostat

MADE EASY

Mechanical Engineering

Toppers Handwritten Notes

Fluid Mechenary

By- Amit Kakkar Sir

- Colour Print Out
- Blackinwhite Print Out
- Spiral Binding,& Hard Binding
- Test Paper For IES GATE PSUs IAS, CAT
- All Notes Available & All Book Availabile
- Best Quaity Handwritten Classroom Notes & Study Materials
- IES GATE PSUs IAS CAT Other Competitive/Entrence Exams

Visit us:-www.hindbookcenter.com

Courier Facility All Over India
(DTDC & INDIA POST)
Mob-9711475393

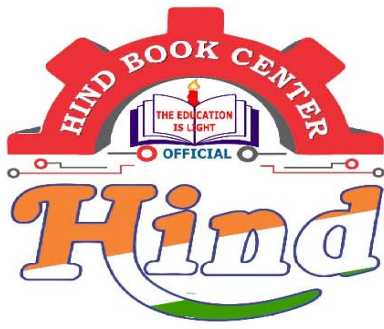

Hindbookcenter



ALL NOTES BOOKS AVAILABLE ALL STUDY MATERIAL AVAILABLE
COURIERS SERVICE AVAILABLE

MADE EASY, IES MASTER, ACE ACADEMY, KREATRYX

ESE, GATE, PSUs BEST QUALITY TOPPER HAND WRITTEN NOTES
MINIMUM PRICE AVAILABLE @ OUR WEBSITE

- | | |
|--------------------------------|---------------------------|
| 1. ELECTRONICS ENGINEERING | 2. ELECTRICAL ENGINEERING |
| 3. MECHANICAL ENGINEERING | 4. CIVIL ENGINEERING |
| 5. INSTRUMENTATION ENGINEERING | 6. COMPUTER SCIENCE |

IES, GATE, PSU TEST SERIES AVAILABLE @ OUR WEBSITE

❖ IES –PRELIMS & MAINS

❖ GATE

➤ NOTE;- ALL ENGINEERING BRANCHS

➤ ALL PSUs PREVIOUS YEAR QUESTION PAPER @ OUR WEBSITE

PUBLICATIONS BOOKS -

MADE EASY, IES MASTER, ACE ACADEMY, KREATRYX, GATE ACADEMY, ARIHANT, GK
RAKESH YADAV, KD CAMPUS, FOUNDATION, MC –GRAW HILL (TMH), PEARSON...OTHERS

HEAVY DISCOUNTS BOOKS AVAILABLE @ OUR WEBSITE

Shop No.7/8 Saidulajab Market Neb Sarai More, Saket, New Delhi-30	Shop No: 46 100 Futa M.G. Rd Near Made Easy Ghitorni, New Delhi-30	F518 Near Kali Maa Mandir Lado Sarai New Delhi-110030	
--	---	--	--

Website: www.hindbookcenter.com

Contact Us: 9711475393

Fluid



Dynamics of fluid

Energy Equation

F/M

Energy of fluid

1st

$$P + \frac{1}{2} \rho v^2 + \rho g z \left] \begin{array}{l} \text{energy per} \\ \text{unit volume} \end{array} \right.$$

2nd

$$\frac{P}{\rho g} + \frac{v^2}{2g} + z \left] \begin{array}{l} \text{energy per unit} \\ \text{weight or load} \\ \text{form.} \end{array} \right.$$

H/M

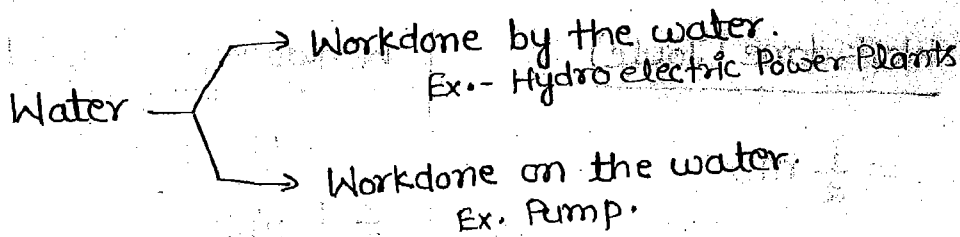

Classification of Hydraulic Machines :-

Turbines :- Workdone by the water.

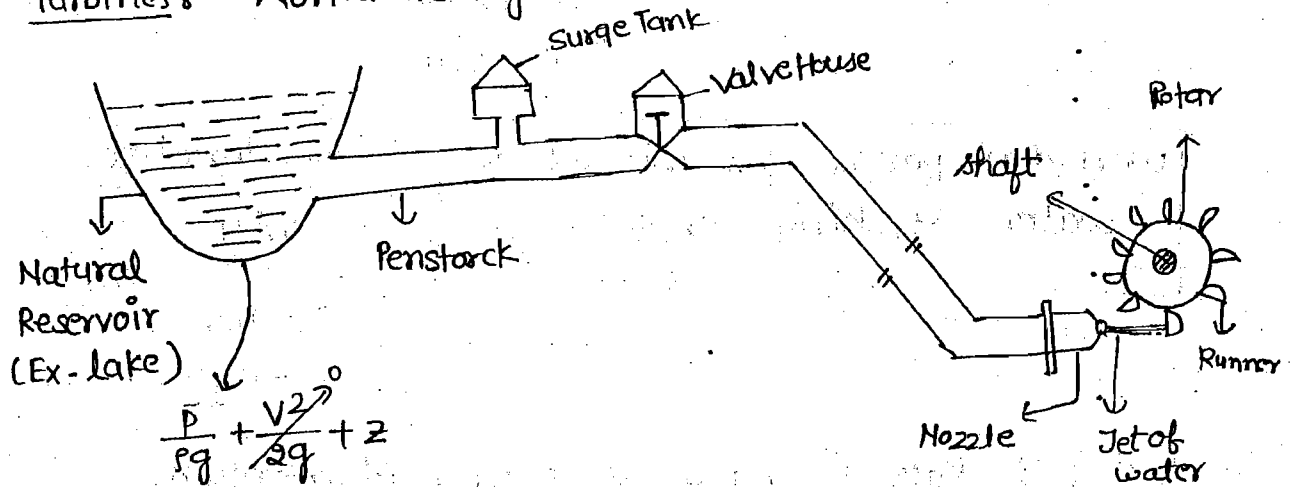

Hydraulic Energy \Rightarrow Mechanical shaft Power \Rightarrow electricity
(electric Power)

Runner: Rotal having a series of vanes.

PUMP: Workdone on the water.

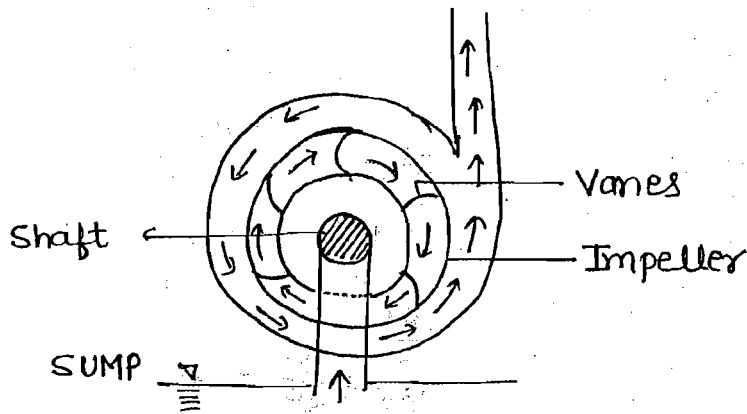

Electrical Energy \Rightarrow Mechanical shaft work \Rightarrow Hydraulic Energy.

Work done (Joule)

$$= \frac{1}{2} mv^2$$

$$= mgh$$

$$= Fx \cdot x$$

$\frac{1}{2}mv^2 = \frac{1}{2}\omega^2 r^2 m$
 mgh
 $Fx \cdot x$

Workdone/sec. (watt)

or
(Power)

$$= \frac{1}{2} mv^2$$

$$= mgh$$

$$= Fx \cdot u$$

$$P = T \cdot \omega$$

$\frac{1}{2}mv^2$
 mgh
 $Fx \cdot u$
 $P = T \cdot \omega$

workdone per sec. per unit wt. of water striking per sec. (m)	=	$\frac{\text{workdone/sec}}{mg}$
---	---	----------------------------------

when $H=30$ $mgh = \text{watt}$

Torque is Rate of change of angular Momentum.

where angular Momentum is moment of linear Momentum.

Cause of Workdone \Rightarrow Force

Newton's 2nd Law -

$$\vec{F}_{\text{ext.}} = \frac{d}{dt} (m \cdot \vec{v})$$

↓
system (water)

Force exerted on the water

$$\vec{F}_{\text{water}} = \dot{m} (\vec{v}_2 - \vec{v}_1) \quad \text{In pumps}$$

Force exerted by the water

$$\vec{F} = -\vec{F}_{\text{water}} \quad (\text{Newton's 3rd law})$$

$$\vec{F} = \dot{m} (\vec{v}_1 - \vec{v}_2) \quad \text{In turbines}$$

\vec{v}_2 = Absolute Velocity of water at exit.

\vec{v}_1 = absolute velocity of water at inlet.

Dwt Requirement :-

(1)

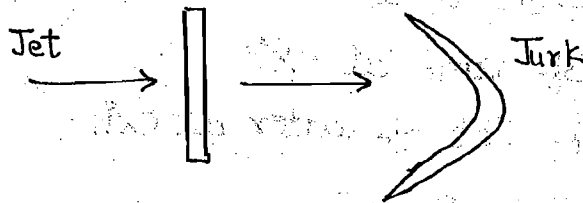

Smooth Entry \rightarrow

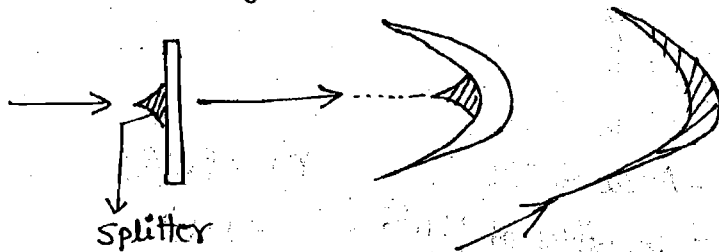

(2) force in -x-dirⁿ & not in y-dirⁿ
 otherwise misalignment of Rotar.

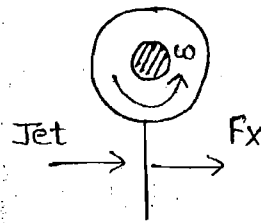

Impact of Jet :-

Suffix:

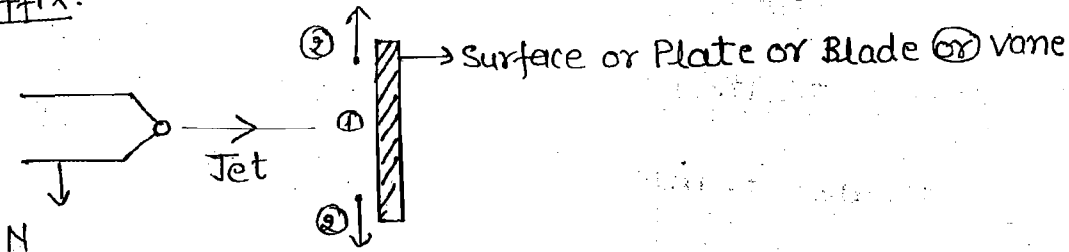

Entry at vane \Rightarrow ①

Exit from Vane \Rightarrow ②

At inlets:-

$V_1 \Rightarrow$ Absolute Velocity of Jet of water at inlet.

$u_1 \Rightarrow$ Absolute velocity of Vane at inlet.

$V_{r1} \Rightarrow$ Relative Velocity of Jet of water.

At exit:

$V_2 =$ Absolute velocity of Jet of water at exit.

$u_2 =$ Absolute Velocity of vane at exit

$V_{r2} =$ Relative velocity of Jet of water at exit.

Mass Flow Rate Responsible for Force :

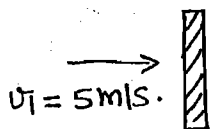

$$\begin{aligned} \dot{m} &= \rho a V_1 \\ &= \rho a (5) \end{aligned}$$

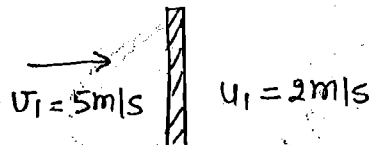

$$\begin{aligned} a &= \text{Area of Jet} \\ \rho &= \text{Density of fluid} \end{aligned}$$

$$\begin{aligned} \dot{m} &= \rho a V_{r1} \\ &= \rho a (5-2) \\ &= \rho a (3) \end{aligned}$$

The mass flow rate responsible for the force will be calculated on the basis of relative velocity.

Impact of Jet :

Aim :- Designing of the shape of Vanes.

Requirement :

$$F_x = \dot{m} u_1$$

$$F_y = 0$$

Stationary Surface :

(1) Flat :-

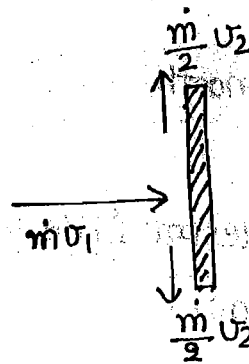
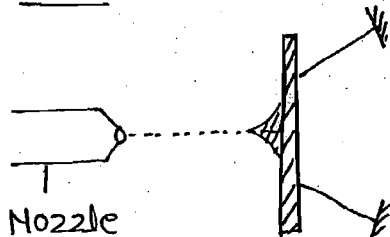

Assume

Vane surface is smooth.

$$u_2 = u_1$$

Mass flow Rate Responsible for force -

$$\dot{m} = \rho a u_1$$

F_x = Initial Momentum/sec in the x-dirⁿ - Final Momentum/sec in the x-dirⁿ.

$$F_x = \dot{m} u_1 - 0 = \dot{m} u_1 = (\rho a u_1) \cdot u_1$$

$$F_x = \rho a u_1^2$$

F_y = Initial Momentum/sec in the y-dirⁿ - Final Momentum/sec in y-dirⁿ.

$$= 0 - \left[\frac{\dot{m}}{2} u_2 - \frac{\dot{m}}{2} u_2 \right] \quad \boxed{F_y = 0} \text{ as pipe is assumed smooth.}$$

$\{u_2 = u_1\}$

NOTE:

If a jet strikes at 90° then the forces will exist in the same dirⁿ.

(2) Inclined Surface:-

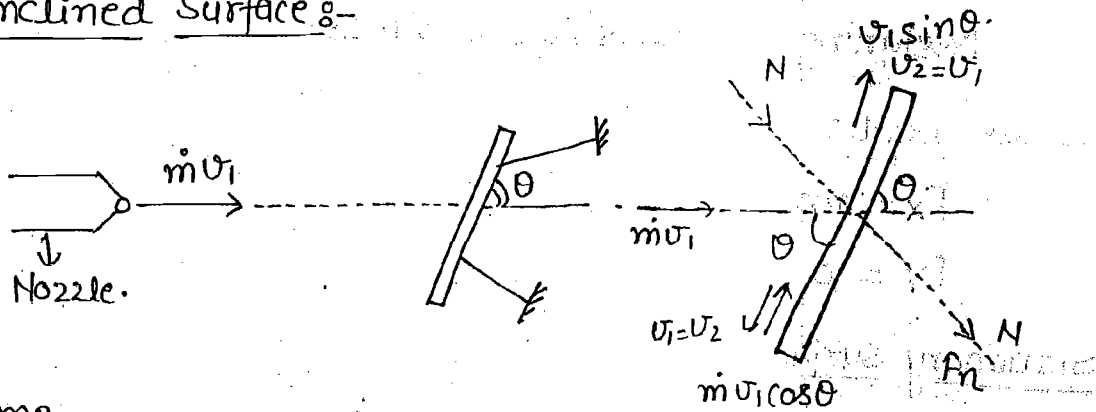

Assume

Vane surface is smooth

$$u_2 = u_1$$

mass flow rate responsible for force

$$\dot{m} = \rho a u_1$$

Now,

$F_n = \text{Initial Momentum/sec} - \text{Final Momentum/sec}$
at inlet in N-dirⁿ at exit in N-dirⁿ.

$$= \dot{m} u_1 \sin \theta - 0$$

$$F_n = \rho a u_1^2 \sin \theta$$

$$F_x = F_n \cos(90^\circ - \theta)$$

$$F_x = \rho a u_1^2 \sin^2 \theta$$

$$F_y = F_n \sin(90^\circ - \theta)$$

$$F_y = \rho a u_1^2 \sin \theta \cos \theta$$